



Designing a new workflow

FDR nano

How often do you encounter the problem with mobile X-ray in a daily medical situation?

FUJIFILM Provides a New Solution with Compact Digital X-ray Cart for Critical Moments you face everyday.



for Operation Room



for NICU



for Emergency Room



for ICU



Amazing future
with "nano"

Patient friendly

Minimum exposure is desirable when taking X-ray images of a new born or infant. Dramatic dose reduction was possible by utilizing FUJIFILM core technology.



Ultra-high sensitivity system

DR Cassette FDR D-EVO II

- High sensitivity reading technology "ISS"
- Noise reduction circuit (NRC) on board



New image processing technology Virtual Grid (VG)

- Provides a high-contrast image without using a grid
- Improves image granularity in low-dose imaging



Virtual Grid

Proprietary technology has achieved a significant dose reduction

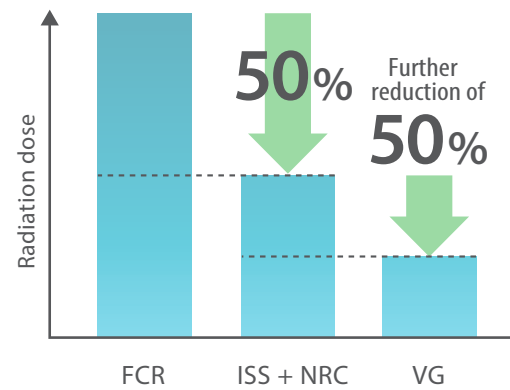

*Using CSI type panels

Small X-ray tube dedicated to the ultra-high sensitivity system



Quiet

Stationary anode X-ray tube does not make noise to surprise the patient

Slim

Easily position the tube head over the incubators

Quick accessibility

Medical scene such as Emergency rooms are crowded with equipments and devices. Freedom of movement is possible with 4 wheel caster and ultra light weight X-ray cart.



Small size and lightweight

Traditional mobile X-ray

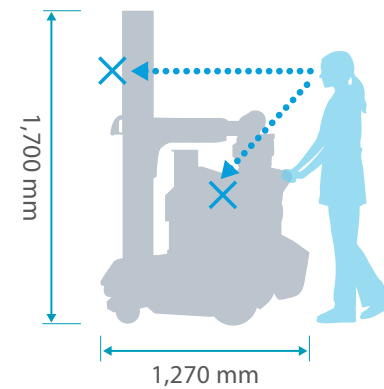

Total weight 500kg X-ray tube 20kg

FDR nano

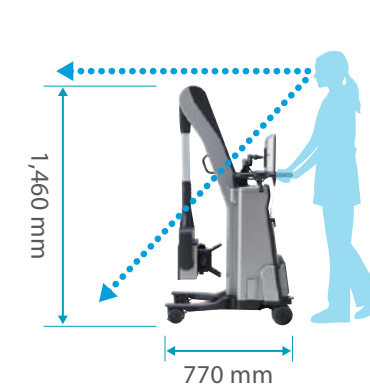

Total weight 90kg X-ray tube 10kg

Exceptional mobility

Spin & slide

4 wheel caster enables superb movement control at ones will.

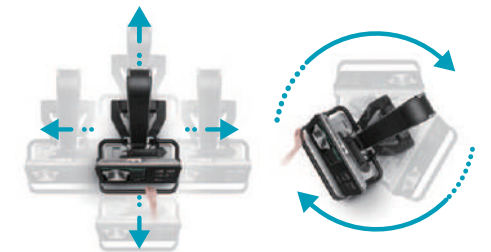

■ Little downtime



High performance Li-ion battery enables quick charge of 4 hours and can be used continuously for 12 hours. Also plugged in exposure is possible.

■ Ready to be used at anytime



D-EVO II is charged when placed in the slot and is quickly taken out with tilting function.

■ Quick viewing while treating



Operation panel can rotate freely according to the doctor's position.

Innovation to the Workflow

Combining FUJIFILM core technology of Cassette DR with Grid-less exposure and compact Digital X-ray cart we provide a innovation to the workflow of taking X-rays.

FDR D-EVO II

DR cassette suitable for mobile exposure

- Easy to insert between patients and bed.
- Light weight panels make easy handling.

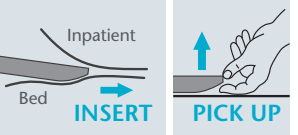

Inpatient Bed **INSERT**

PICK UP

Approx. **2.6 kg**

*D-EVO II C35.

FDR nano SMW (Smart Mobile Workflow)



Digital X-ray cart

- Reduce weight by 1/5 compared to conventional x-ray mobile, providing easy handling.



Virtual Grid

Virtually created grid

- Provide a flexible exam without a physical Grid exam.
- Over come situation where physical grid can be challenging or disruptive to patient comfort.

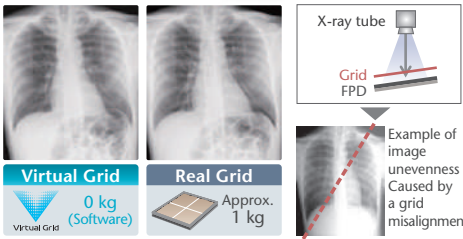

Virtual Grid 0 kg (Software)

Real Grid Approx. 1 kg

X-ray tube
Grid
FPD

Example of image unevenness Caused by a grid misalignment

Pinpoint movement



Even in narrow spaces such as bedside and elevator. Changing direction can be done with ease.

Easy positioning



Simply sliding or turning the whole apparatus enables easy position changes.

The shortest moving distance



The slim body allows technologists to make minimum moves in device operation and positioning.

Maintaining Clean Equipments

Medical equipment surface tends to have high risk for transferring germs, and it is essential to maintaining clean equipments in Operation rooms.



D-EVO II, and some parts of the FDR nano*, we have applied our antibacterial technology "Hydro Ag".

*Shot Switch, surface of Operation Panel

Easy to clean with flat surface



IPX6 waterproofing cassette DR



Easy bagging

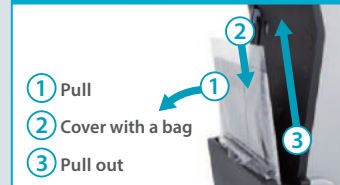

Easy to clean with cordless surface

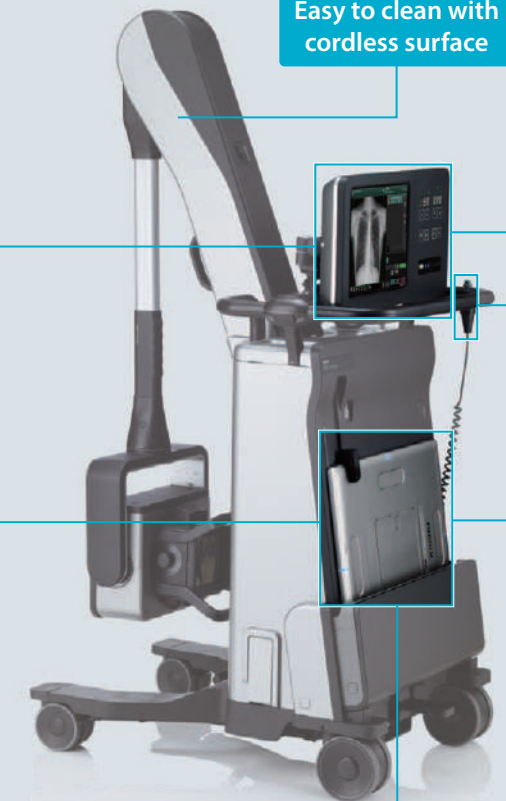

Antibacterial coating



As for the Hydro AG it has high anti bacterial performance preventing germs from growing. This is 100 times more effective than conventional coating, and 10,000 times more protection than surface with no coating.

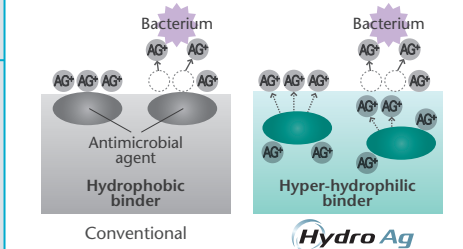

JIS Z 2801/ISO 22196 complied test (Esherichia coil)

Number of residual bacterial after one hour

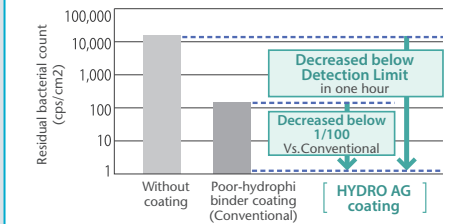

Tested by BOKEN Quality Evaluation Institute Report ID: 20214016660-1(Jul 11,2014)

Specifications

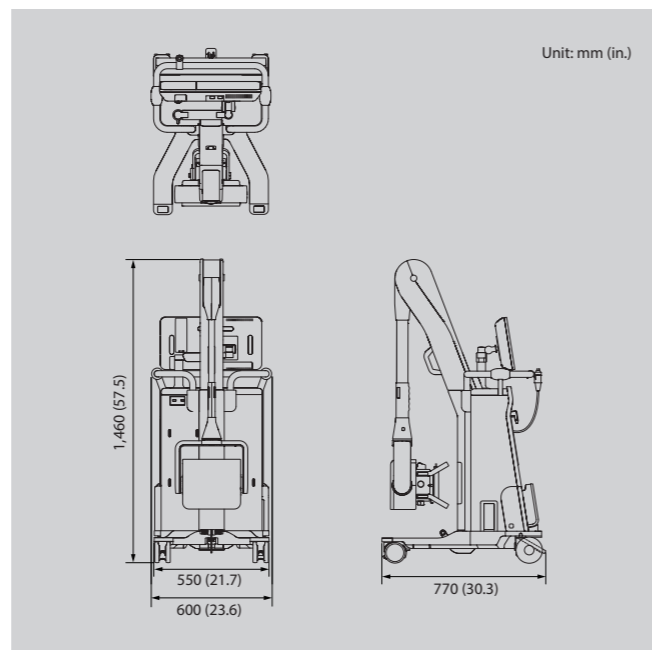



Product name	FDR nano
Model No.	DR-XD1000
Power supply	100-240 V AC, Single phase: 50-60 Hz 8-3.3 A
X-ray output	Max. rating: 2.5 kW Tube voltage: 40-100 kV Tube current: Max 35 mA
X-ray tube	Nominal focal spot size 1.2 mm maximum anode heat capacity 35 kJ (50 kHU) Target angle: 16 degree
Total width	550 mm (excluding handle fix part)
Total length	770 mm
Total height	1,460 mm
Weight	90 kg

Optional Items

- High handle kit
- Added filter
- Accessory case
- Apron hanger
- BCR
- Wet tissue holder
- DAP meter fix kit

System Components : Flat Panel Sensor

	D-EVOII C24	D-EVOII C35	D-EVOII C43
			
Scintillator	CsI (Cesium iodide)	CsI (Cesium iodide)	CsI (Cesium iodide)
Detector external size	328 × 268 × 15 mm (Approx.) [12.9" × 10.6" × 0.6"]	460 × 384 × 15 mm (Approx.) [18" × 15" × 0.6"]	460 × 460 × 15 mm (Approx.) [18" × 18" × 0.6"]
Weight	Approx. 1.5 kg [3.3 lbs.] (including battery)	Approx. 2.6 kg [5.7 lbs.] (including battery)	Approx. 3.2 kg [7.1 lbs.] (including battery)

•Specifications are subject to change without notice. •All brand names or trademarks are the property of their respective owners.
•All products require the regulatory approval of the importing country. •For details on their availability, contact our local representative.

FUJIFILM

Value from Innovation



Designing a new workflow

FDR nano

FUJIFILM

FUJIFILM Corporation
26-30, NISHIAZABU 2-CHOME, MINATO-KU, TOKYO 106-8620, JAPAN
<http://www.fujifilm.com/products/medical/>

Ref. No. XB-0000E (SK-16-10-F1079-F8598) Printed in Japan ©2016 FUJIFILM Corporation

